

[ Front ]

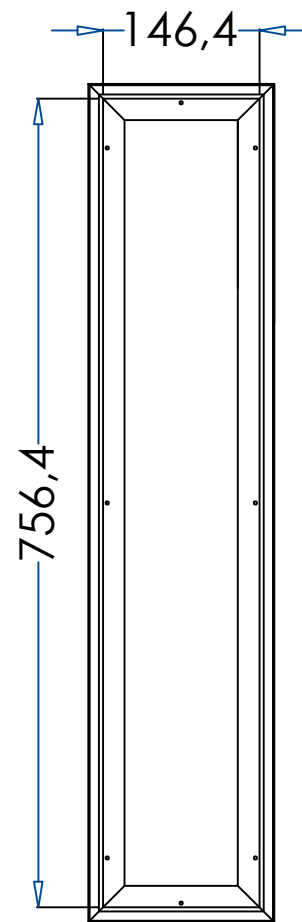

[ Back ]

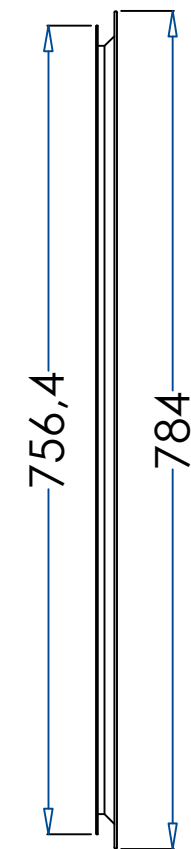

[ Side ]

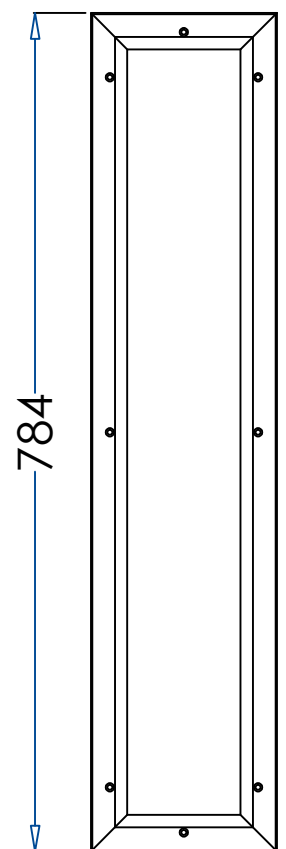

[ Front ]

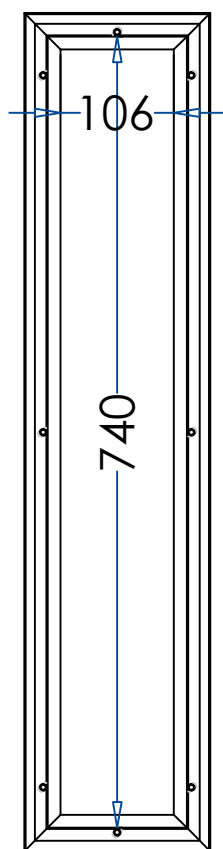

[ Back ]

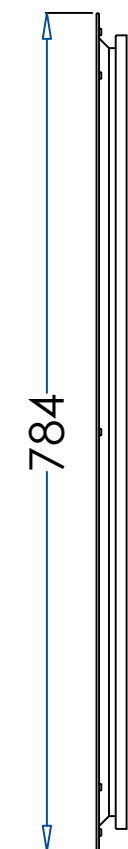

[ Side ]

MODEL: 6" x 30"  
VP- 153 x 763

DRAWN BY:  
Carrie Chen

DRAWING TITLE:

VISION FRAMES

EverPine

Everpine Group Co., Ltd.  
www.dLouver.com

SCALE:  
1 : 1

TEL:  
+86 18756506821