

[Front]

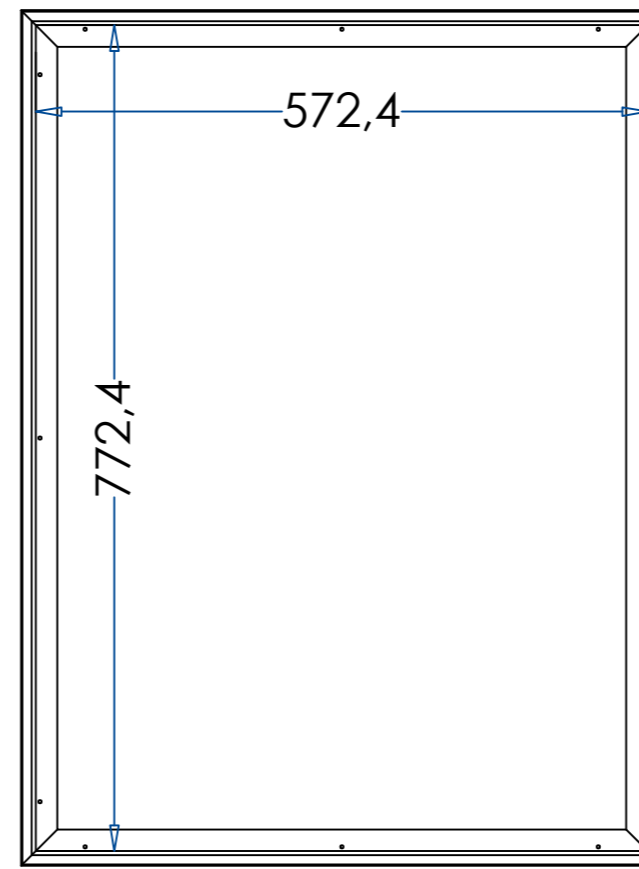

[Back]

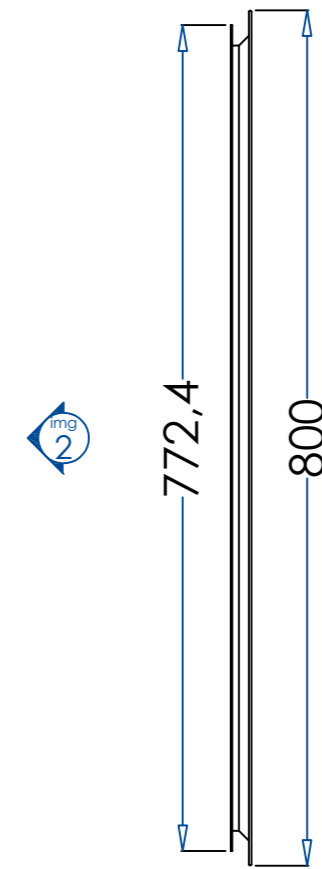

[Side]

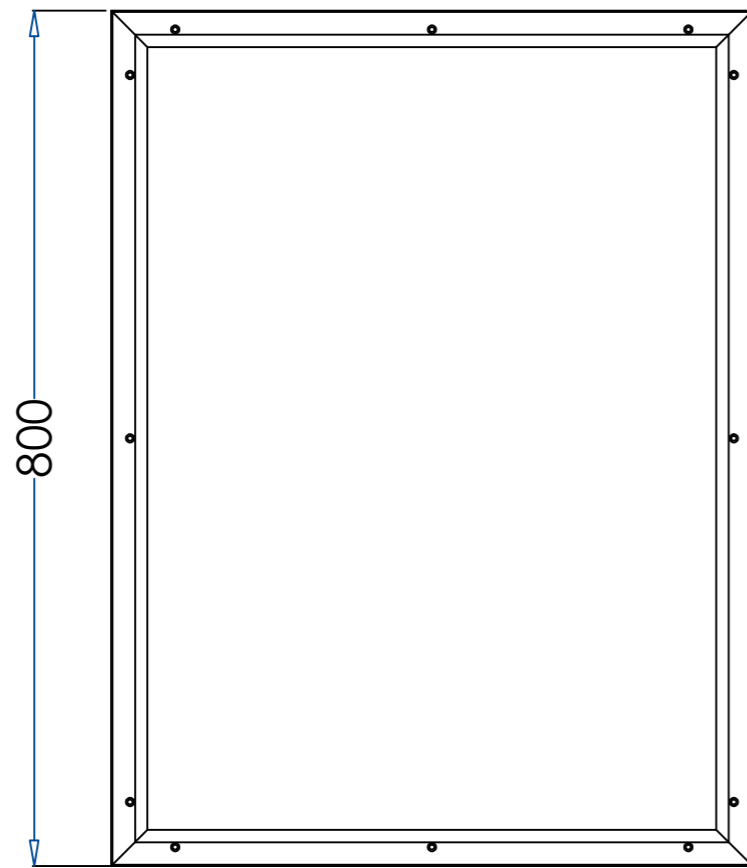

[Front]

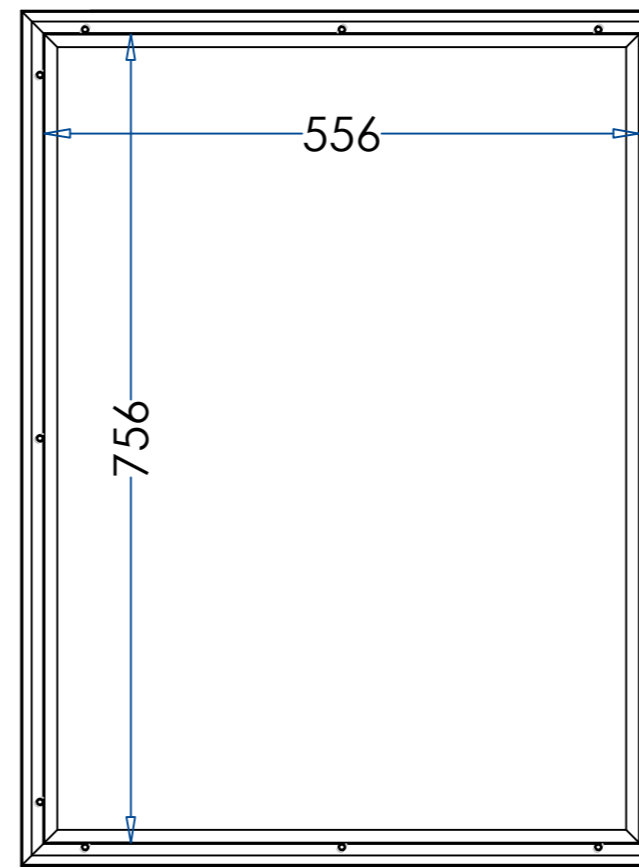

[Back]

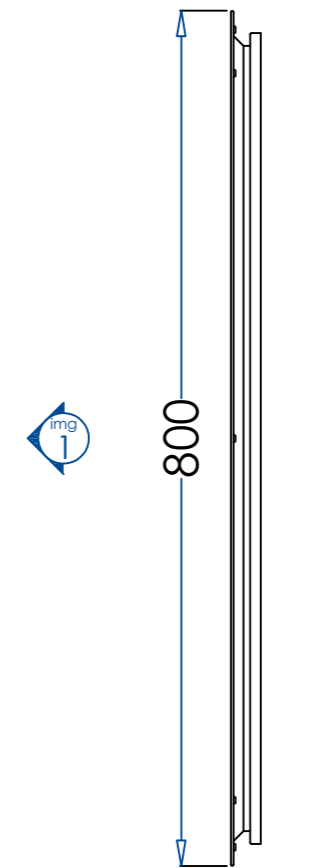

[Side]

MODEL: 23" x 30"
VP- 579 x 779

DRAWN BY:
Carrie Chen

DRAWING TITLE:
VISION FRAMES

EverPine

Everpine Group Co., Ltd.
www.dLouver.com

SCALE:
1 : 1

TEL:
+86 18756506821